

2HSS57-N

7A 60VDC

Closed Loop Stepping System

The 2HSS57-N hybrid stepper servo drive system integrates the servo control technology into the digital stepper drive perfectly. And this product adopts an optical encoder with high speed position sampling feedback of $50\mu s$, once the position deviation appears, it will be fixed immediately. This product is compatible the advantages of the stepper drive and the servo drive, such as lower heat, less vibration, fast acceleration, and so on. This kind of servo drive also has an excellent cost performance.



Pulse/rev Table

Pulse/rev	Sw3	Sw4	Sw5	Sw6
Default	on	on	on	on
800	off	on	on	on
1600	on	off	on	on
3200	off	off	on	on
6400	on	on	off	on
12800	off	on	off	on
25600	on	off	off	on
51200	off	off	off	on
1000	on	on	on	off
2000	off	on	on	off
4000	on	off	on	off
5000	off	off	on	off
8000	on	on	off	off
10000	off	on	off	off
20000	on	off	off	off
40000	off	off	off	off

RS232

PA Setting Sw8 Sw7 Sw6 Sw5 Sw4 Sw3 Sw2 Sw1

Break+ Break- PEND+ PEND-

Sw1: 单双脉冲 (Pulse Mode), off=PUL/DIR, on=CW/CCW
Sw2: 旋转方向 (Motor DIR), off=CCW, on=CW
Sw7: 指令平滑 (Pulses Smooth)
off=Smoothness off(关), on=Smoothness on(开)
Sw8: 开闭环 (Open/Close Loop), off=Close Loop, on=Open Loop



- Without losing step, High accuracy in positioning
- 100% rated output torque
- Variable current control technology, High current efficiency
- Small vibration, Smooth and reliable moving at low speed
- Accelerate and decelerate control inside, Great improvement in smoothness of starting or stopping the motor
- User-defined micro steps
- Compatible with 1000 and 2500 lines encoder
- No adjustment in general applications
- Over current, over voltage and over position error protection
- Green light means running while red light means protection or off line

Electrical Specifications

Parameter	Min	Typical	Max	Unit
Input Voltage(DC)	24	36	60	VDC
Output Current	0	-	7.0	A
Pulse Signal Frequency	0	-	200	kHz
Logic Signal Current	7	10	16	mA
Insulation resistance	500	-	-	$m\Omega$
Encoder current providing	-	-	50	mA

Micro steps Setting

The micro steps setting is in the following table, while SW3, SW4, SW5, SW6 are all on, the internal default micro steps inside is activate (it is possible to set this via RS232/(USB like connector, but not USB) - P20 user-defined p/r: $(4 - 1000) * 50$).

Pulse/rev	Sw3	Sw4	Sw5	Sw6
Default	on	on	on	on
800	off	on	on	on
1600	on	off	on	on
3200	off	off	on	on
6400	on	on	off	on
12800	off	on	off	on
25600	on	off	off	on
51200	off	off	off	on
1000	on	on	on	off
2000	off	on	on	off
4000	on	off	on	off
5000	off	off	on	off
8000	on	on	off	off
10000	off	on	off	off
20000	on	off	off	off
40000	off	off	off	off

Sw1: 单双脉冲 (Pulse Mode), off=PUL/DIR, on=CW/CCW
Sw2: 旋转方向 (Motor DIR), off=CCW, on=CW
Sw7: 指令平滑 (Pulses Smooth)
off=Smoothness off(关), on=Smoothness on(开)
Sw8: 开闭环 (Open/Close Loop), off=Close Loop, on=Open Loop

SW1 is used for setting puls mode of the input signal, "off" means PUL/DIR (most often needed), while "on" is CW/CCW.

SW2 is used for setting the running direction, "off" means CCW, while "on" means CW.

SW7 is used to turn smoothness on (off) or off (on)
The level of smoothness depends on the parameter P19, set by RS232 (USB like connector, but not USB).

SW8 allows you to disable motor encoder support. With Open Loop you can control a normal stepper motor w/o encoder.

Typical Connection

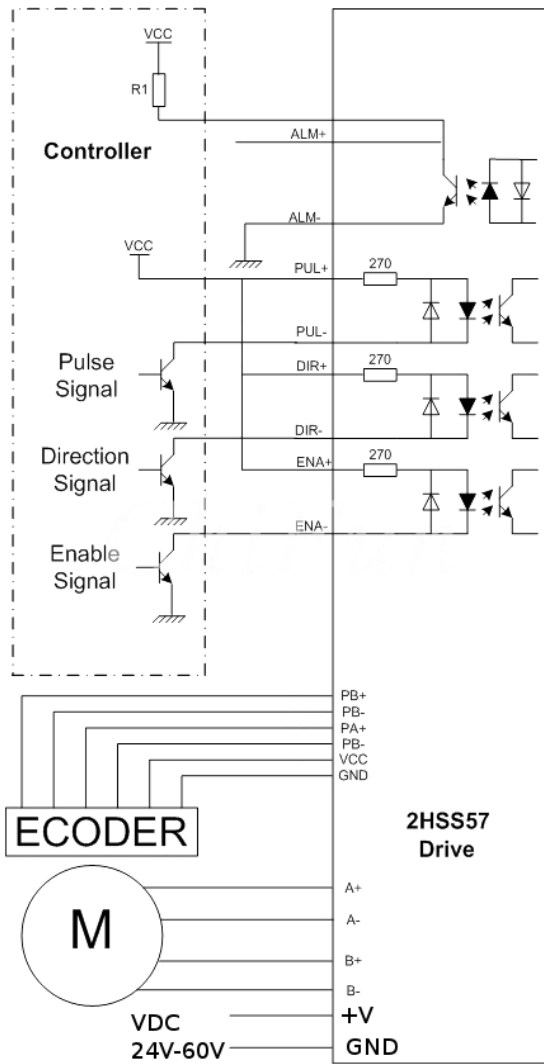

Encoder

PB+/PB- Encoder phase B

PA+/PA- Encoder phase A

VCC/GND +5V powering of motor encoder

Faults alarm and LED flicker frequency

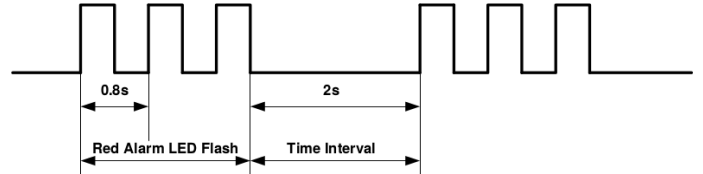

blink	Description to the Faults
1	Error occurs when the motor coil current exceeds the drive's current limit.
2	Voltage reference error in the drive
3	Parameters upload error in the drive
4	Error occurs when the input voltage exceeds the drive's voltage limit
5	Error occurs when the actual position following error exceeds the limit which is set by the position error limit

Mechanical Specifications

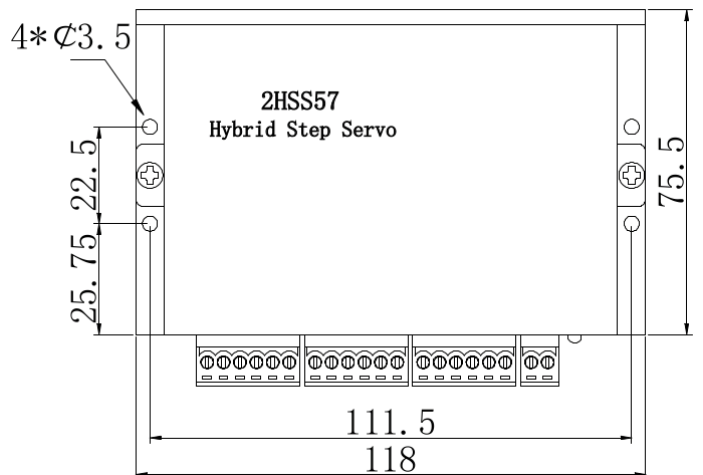
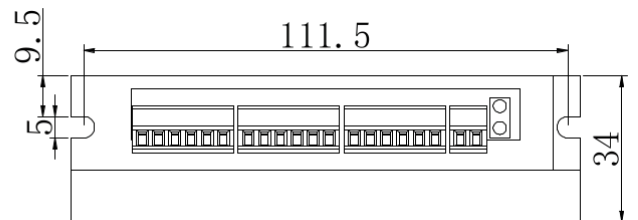

Input Control Signal

PLS+/PLS- Puls signal (clk/step)

DIR+/DIR- Direction signal

ENA+/ENA- Enable (free) signal

Output Alarm Signal

Pend+/Pend- OC output, Normally open

ALM+/ALM- OC output, Normally closed

ALM load current $\leq 50mA$

Power and Motor Connector

A+/A- Motor Phase A

B+/B- Motor Phase B

V+/GND Power Input

Brake control

BRK+/BRK- Collector/Emitter

Parameter Setting

The parameter setting method of 2HSS57 drive is to use a HISU adjuster through the RS232 serial communication ports¹, only in this way can we setting the parameters we want. There are a set of best default parameters to the corresponding motor which are carefully adjusted by our engineers, users only need refer to the following table, specific condition and set the correct parameters.

Actual value = Set value × the corresponding dimension

Mode	Definition	Range	Dimension	Drive Restart	Default Value
P1	Current loop K_p	0 – 4000	1	<i>N</i>	1000
P2	Current loop integral K_i	0 – 1000	1	<i>N</i>	100
P3	Damping coefficient	0 – 1000	1	<i>N</i>	100
P4	Position loop K_p	0 – 4000	1	<i>N</i>	1300
P5	Position loop integral K_i	0 – 1000	1	<i>N</i>	250
P6	Speed loop K_p	0 – 3000	1	<i>N</i>	50
P7	Speed loop integral K_i	0 – 1000	1	<i>N</i>	10
P8	Open loop current [0.1 * A]	0 – 50	0.1	<i>N</i>	30
P9	Close loop current [0.1 * A]	0 – 50	0.1	<i>N</i>	30
P10	Alarm level	0 – 1	1	<i>N</i>	0
P11	Reserved				
P12	Stop lock enable	0 – 1	1	<i>N</i>	0
P13	Enable signal level	0 – 1	1	<i>N</i>	0
P14	Arrival level	0 – 1	1	<i>N</i>	0
P15	Encoder line number	0 – 1	1	<i>Y</i>	0
P16	Position error limit	0 – 3000	10	<i>N</i>	1000
P17	Reserved				
P18	Motor type	0 – 5	0	<i>Y</i>	3
P19	Speed smoothness	0 – 10	1	<i>N</i>	6
P20	User-defined p/r	4 – 1000	50	<i>Y</i>	8

There are total 20 parameter configurations, use the HISU to download the configured parameters

¹2HSS57 has a connector like USB, but it is RS232 terminal. DO NOT CONNECT USB !.

to the drive, the detail descriptions to every parameter configuration are as follows:

P1 Current loop K_p Proportional Gain Increase K_p to make current rise fast. Proportional Gain determines the response of the drive to setting command. Low Proportional Gain provides a stable system (doesn't oscillate), has low stiffness, and the current error, causing poor performances in tracking current setting command in each step. Too large proportional gain values will cause oscillations and unstable system.

P2 Current loop K_i Integral Gain Adjust K_i to reduce the steady error. Integral Gain helps the drive to overcome static current errors. A low or zero value for Integral Gain may have current errors at rest. Increasing the integral gain can reduce the error. If the Integral Gain is too large, the system may "hunt" (oscillate) around the desired position.

P3 Damping coefficient This parameter is used to change the damping coefficient in case of the desired operating state is under resonance frequency.

P4 Position loop K_p & P5 K_i The *PI* parameters of the position loop. The default values are suitable for most of the application, you don't need to change them. Contact us if you have any question.

P6 Speed loop K_p & P7 K_i The *PI* parameters of the speed loop. The default values are suitable for most of the application, you don't need to change them. Contact us if you have any question.

P8 Open loop current This parameter affects the static torque of the motor.

P9 Close loop This parameter affects the dynamic torque of the motor. (The actual current = open loop current + close loop current)

P10 Alarm Control This parameter is set to control the Alarm optocoupler output transistor. 0 means the transistor is cut off when the system is in normal working, but when it comes to fault of the drive, the transistor becomes conductive. 1 means opposite to 0.

P12 Stop lock enable This parameter is set to enable the stop clock of the drive. 1 means enable this function while 0 means disable it.

P13 Enable Control This parameter is set to control the Enable input signal level, 0 means low, while 1 means high.

P14 Arrival Control This parameter is set to control the Arrival optocoupler output transistor. 0 means the transistor is cut off when the drive satisfies the arrival command, but when it comes to not, the transistor becomes conductive. 1 means opposite to 0.

P15 Encoder resolution This drive provides two choices of the number of lines of the encoder. 0 means 1000 lines, while 1 means 2500 lines.

P16 Position error limit The limit of the position following error. When the actual position error exceeds this value, the drive will go into error mode and the fault output will be activated. (The actual value = the set value \times 10)

P18 Motor type

P18	1	2	3	4	5
motor type	42J 1848EC	57J 1854EC	57J 1880EC	60J 1847EC	60J 1887EC
I [A]	1.3	4	3		5
L [mH]	3.8	1.4	1.9		1.8
R [Ω]	2.4	0.44	4		0.45
torque [Nm]	0.52	1.2	0.85		3
inertia [gcm^2]	68	280	480		690

- Default Value = "3" means 3A motor.

P19 Speed smoothness This parameter is set to control the smoothness of the speed of the motor while acceleration or deceleration, the larger the value, the smoother the speed in acceleration or deceleration.

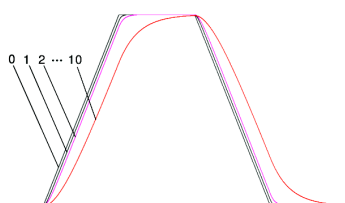

P20 User-defined p/r This parameter is set of user-defined pulse per revolution, the internal default micro steps inside is activate while SW3, SW4, SW5, SW6 are all on, users can also set the micro steps by the outer DIP switches. (The actual micro steps = the set value \times 50)

Processing Methods to Common Problems and Faults

Power on power light off

- No power input, please check the power supply circuit. The voltage is too low.

Power on red alarm light on

- Please check the motor feedback signal and if the motor is connected with the drive.
- The stepper servo drive is over voltage or under voltage. Please lower or increase the input voltage.

Red alarm light on after the motor running a small angle

- Please check the motor phase wires if they are connected correctly.

RS232C - connector microUSB

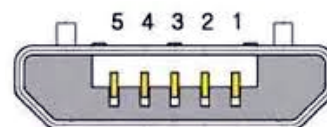
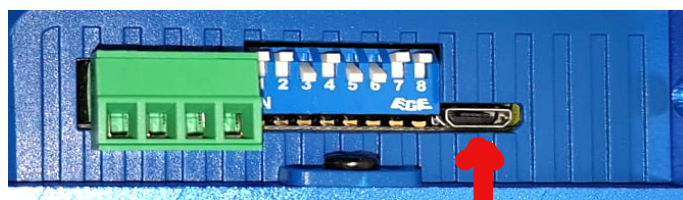

- | | |
|---|---|
| 5 | GND |
| 4 | — |
| 3 | RX232 |
| 2 | TX232 |
| 1 | +5V |
| | +5V do not connect to the RS232C cable |
| | +5V supply from 2HSS57 only needed for HISU |